

Technical Data Sheet

Bonded Neodymium Disc Magnets

Neodymium magnets are part of the Rare Earth magnet family and are the most powerful permanent magnets in the world. They are referred to as NdFeB magnets, or NIB, because they are composed of Neodymium (Nd), Iron (Fe) and Boron (B).

Product Specifications

Shape:	Disc
Tolerance:	.005
Material:	NdFeB
Max. Operating Temperature:	302°
Br. Max:	6800
BH Max:	10



Part No.	Diameter	Thickness	Holding Force	Price
NB019-AM	0.984	0.197	3.6	\$14.57

Call 1-847-593-2060 for quantity discounts.

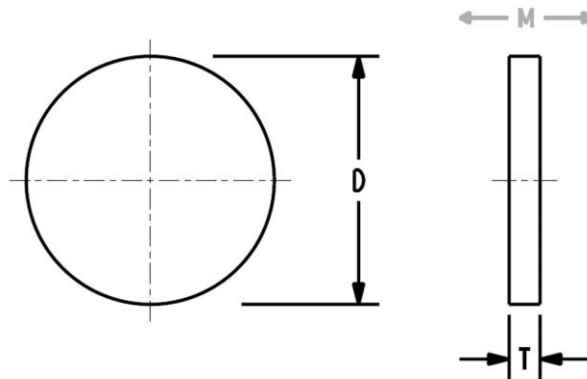

- All Measurements are in inches (unless otherwise noted)
- Direction of Magnetization (DOM) is through the thickness unless noted
- Unless otherwise specified, magnets will be furnished in magnetized condition
- Holding forces are approximate. These are average values obtained under laboratory conditions. Size, shape, and material of the test piece may affect actual pull forces