



GLOBAL. MAGNETIC. FORCE.™

Technical Data Sheet

Alnico U-Shaped Magnet, Square Cutout, Grade 5

Alnico magnets are widely used in industrial and consumer applications where strong permanent magnets are needed; examples are electric motors, electric guitar pickups, microphones, sensors, loudspeakers, traveling wave tubes, and cow magnets.

Product Specifications

Shape:	U-Shaped
Tolerance:	.005
Material:	AlNiCo
Plating:	None
Max. Operating Temperature:	1000°
Br. Max:	12700
BH Max:	5.5



Part No.	A	B	C	D	E	G	Wt. (lbs)	Holding Force (lbs)	Price
CU618	1.375	1.375	.687	.487	.495	.312	.415	13	\$71.31

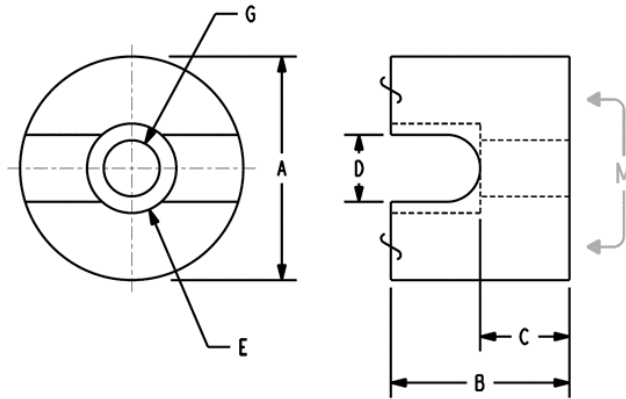

- All Measurements are in inches (unless otherwise noted)
- Direction of Magnetization (DOM) is through the thickness unless noted
- Unless otherwise specified, magnets will be furnished in magnetized condition
- Holding forces are approximate. These are average values obtained under laboratory conditions. Size, shape, and material of the test piece may affect actual pull forces

