



GLOBAL. MAGNETIC. FORCE.™

Technical Data Sheet

Neodymium Pot Magnets, BN6 Series

Neodymium Countersunk Rings and Countersunk Ring Magnets are made in a variety of sizes and grades to meet all types of applications. To accomplish a flush and smooth finish, use Neodymium Ring Magnets made with a single (or double) countersunk hole.

Product Specifications

Shape:	Ring
Tolerance:	.005
Material:	NdFeB
Plating:	Ni
Max. Operating Temperature:	180°
Br. Max:	12800
BH Max:	42



Part No.	Outside Diameter	Inside Diameter	Thickness	Screw Size	Holding Force(lbs)	Price
BN6-20	.787	.177	.236	#6	23.6	\$1.56

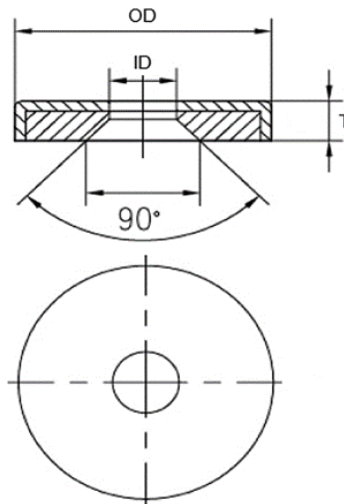

- All Measurements are in inches (unless otherwise noted)
- Direction of Magnetization (DOM) is through the thickness unless noted
- Unless otherwise specified, magnets will be furnished in magnetized condition
- Holding forces are approximate. These are average values obtained under laboratory conditions. Size, shape, and material of the test piece may affect actual pull forces

