



GLOBAL. MAGNETIC. FORCE.™

Technical Data Sheet

Ceramic Pot Magnets, Three-Pole, Tapped

Ceramic Holding Assemblies provide a strong magnetic field. The ceramic magnet material possesses high coercive force and resists demagnetization from heat, vibration, and electrical fields. Most of our ceramic assemblies are permanently embedded in epoxy plastic. They are typically more economical than Alnico assemblies and can be used in temperatures up to 180°F. Temperatures higher than 180°F can cause the standard epoxy that holds the magnet material to fail.

Product Specifications

Shape:	Assembly
Tolerance:	.005
Material:	SrFe
Plating:	None
Max. Operating Temperature:	180°
Br. Max:	3850
BH Max:	8



Part No.	D	L	Tap Size	Depth	Holding Value (lbs)	Price
BM1942TX3/4	1.250	.750	#.25-20	.1875	40.0	\$20.52

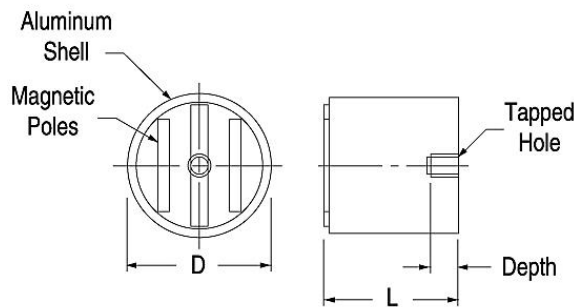

- All Measurements are in inches (unless otherwise noted)
- Direction of Magnetization (DOM) is through the thickness unless noted
- Unless otherwise specified, magnets will be furnished in magnetized condition
- Holding forces are approximate. These are average values obtained under laboratory conditions. Size, shape, and material of the test piece may affect actual pull forces

