

Technical Data Sheet

Round Electromagnets, Flat-Faced

BuyMagnets.com Round electromagnets handle ferrous materials safely and securely. Electromagnets provide an efficient and economical solution for handling and holding parts. Available in a number of shapes and sizes, our electromagnets require little maintenance and can be used in a variety of manual and automated applications. (Special sizes upon request).

Product Specifications

Shape:

Round



Part No.	Diameter(A)	Height (B)	Thread (C)	Thread Depth (D)	DC Volts	Watts	Pull Force	Wt.	Price
BDE-1212-12	1.25	1.250	.25-20	.375	12	4.5	40	4.20oz	\$24.00

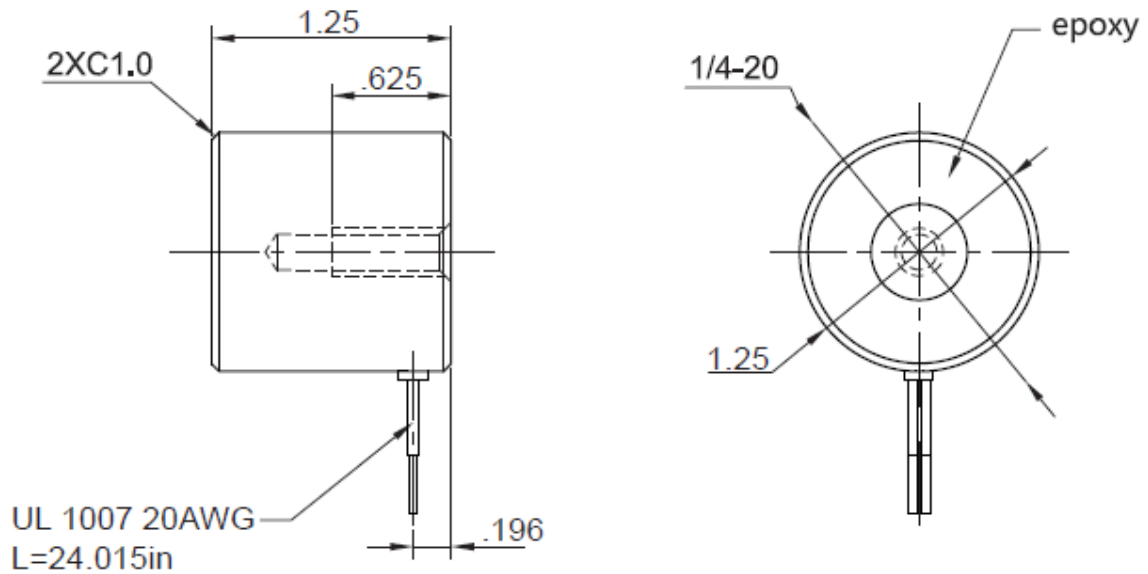

- All Measurements are in inches (unless otherwise noted)
- Direction of Magnetization (DOM) is through the thickness unless noted
- Unless otherwise specified, magnets will be furnished in magnetized condition
- Holding forces are approximate. These are average values obtained under laboratory conditions. Size, shape, and material of the test piece may affect actual pull forces