

Technical Data Sheet

Alnico Magnets, BA Series

Utility-Grade assemblies for a wide variety of mass market applications. The BA Series magnets use Alnico magnets with a brass insulator and Zinc plated steel cup. These magnets can be used in high temperature applications up to 840°F. BA series magnets can be used with our available hooks.

Product Specifications

Shape:	Assembly
Tolerance:	.005
Material:	AlNiCo
Plating:	Zn
Max. Operating Temperature:	840°



Part No.	D	H	Tap Size (MG)	Holding Force (lbs)	Price
BA16	.63	.79	M4x5	4.0	\$1.98

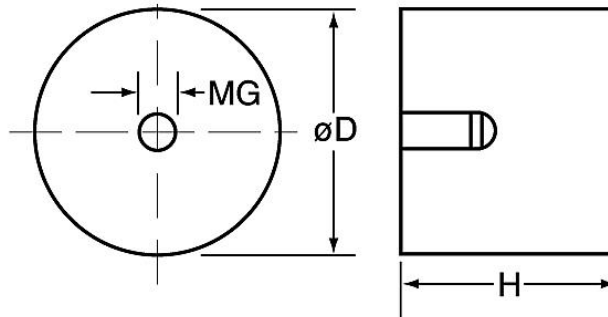

- All Measurements are in inches (unless otherwise noted)
- Direction of Magnetization (DOM) is through the thickness unless noted
- Unless otherwise specified, magnets will be furnished in magnetized condition
- Holding forces are approximate. These are average values obtained under laboratory conditions. Size, shape, and material of the test piece may affect actual pull forces